

Article number: 25150664002

Description: ICME Single-phase motor MD100 B6 1,5KW
6 - 900 rpm 1x230 Volt 50Hz B5 with starting & running capacitor

Measures

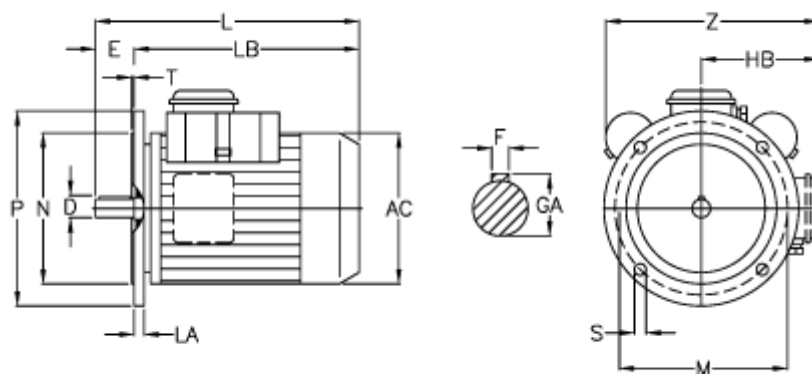

AC = 195	LB = 343
D = 28	M = 215
E = 60	N = 180
F = 8	P = 250
GA = 31.0	S = 14.0
HB = 140	T = 4.0
L = 403	Z = 260
LA = 14.0	